

PRODUCT INDEX

<i>Aisle brace for - bolted type shelving</i>	U-04
<i>Aisle brace for - offset type shelving</i>	U-04
<i>Aisle brace for - rivet type shelving</i>	U-15
<i>Angle sway brace</i>	U-02, 05
<i>Beam for rivet type shelving</i>	U-16
<i>Bin front for bolted type shelving</i>	U-12
<i>Bin front for box type shelving</i>	U-12
<i>Bin front for offset type shelving</i>	U-12
<i>Corner reinforcement plate</i>	U-18
<i>Cutter for slotted angle</i>	U-18
<i>Divider</i>	U-13
<i>Divider clip</i>	U-13, 14
<i>Foot plate</i>	U-02, 17
<i>Hardware (nuts and bolts)</i>	U-02, 14
<i>Joiner plate</i>	U-17
<i>Kickplate for 1" offset shelving</i>	U-04
<i>Kickplate for offset and bolted type shelving</i>	U-04
<i>Label moulding</i>	U-11
<i>L-Shaped post 1" x 1¾" bolted type</i>	U-05
<i>L-Shaped post 1¼" x 1¼" bolted type</i>	U-05
<i>Mobile shelf truck</i>	U-20
<i>Offset post 1" c/c - 1" x 1 7/8" - Rear</i>	U-01
<i>Offset post 1" c/c - 1/2" x 1 7/8" - Front</i>	U-01
<i>Regular shelf reinforcement 1" x 1" - 12ga</i>	U-11
<i>Rivet type post</i>	U-15
<i>Service cart</i>	U-19
<i>Shelf box (drawer)</i>	U-11
<i>Shelf box divider</i>	U-11
<i>Shelf box guide</i>	U-11
<i>Shelf clip for 1" c/c offset post</i>	U-06
<i>Shelf medium duty - 18GA</i>	U-10
<i>Shelf medium duty - 20GA</i>	U-09
<i>Shelf medium duty - 22GA</i>	U-08
<i>Shelf regular - 18GA</i>	U-07
<i>Shelf regular - 20GA</i>	U-06
<i>Shim</i>	U-02
<i>Side and back panel for bolted type shelving</i>	U-03
<i>Slotted angle - painted finish</i>	U-18
<i>Splice (joiner)</i>	U-02, 05
<i>Splice (joiner) 1" x 1" x 5"</i>	U-17
<i>Sway brace (pair)</i>	U-02, 05
<i>Tie bar</i>	U-17
<i>Wall spacer</i>	U-17

REAR OFFSET POST 1" c/c - 1" x 1 7/8"



310-OP39	39"	2.00 lb
310-OP51	51"	3.00 lb
310-OP63	63"	4.00 lb
310-OP75	75"	4.80 lb
310-OP87	87"	5.50 lb
310-OP99	99"	6.00 lb
310-OP111	111"	7.00 lb
310-OP123	123"	8.00 lb
310-OP135	135"	8.80 lb
310-OP147	147"	9.50 lb
310-OP159	159"	10.30 lb
310-OP171	171"	11.00 lb
310-OP183	183"	12.10 lb
310-OP195	195"	13.20 lb

FRONT OFFSET POST 1" c/c - 1/2" x 1 7/8"



310-BP39	39"	2.20 lb
310-BP51	51"	3.20 lb
310-BP63	63"	4.50 lb
310-BP75	75"	5.40 lb
310-BP87	87"	6.30 lb
310-BP99	99"	7.20 lb
310-BP111	111"	8.10 lb
310-BP123	123"	9.00 lb

OVERALL DIMENSION SPECIFICATION

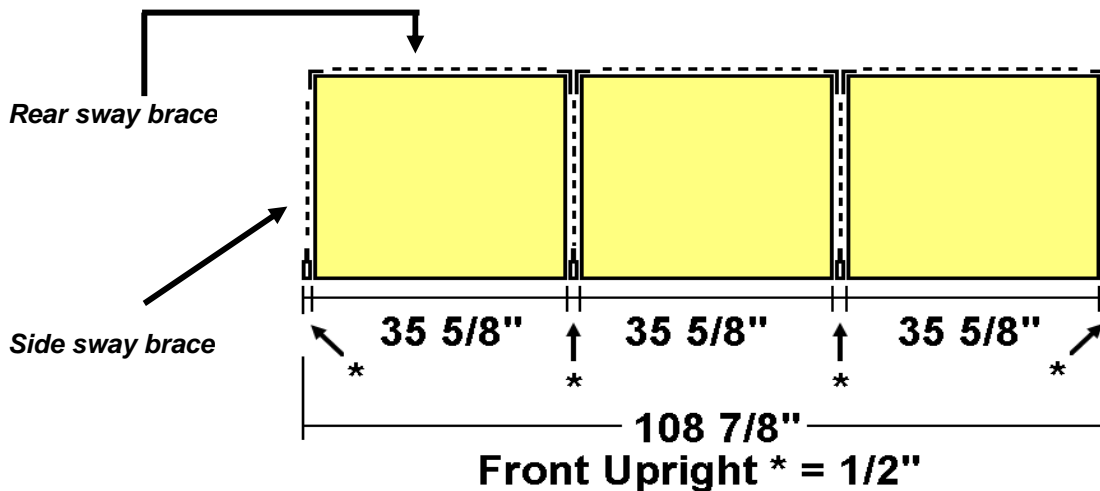

FOOT PLATE, SHIM AND SPLICE



Foot Plate

310-FPOP1 for 1" offset post 0.30 lb

Shim

310-SHIM Raw 0.20 lb
310-SHIMP Painted 0.20 lb



Splice (joiner)

300-OSP1 for 1" offset post 0.20 lb
3/4" x 1" x 5"

SWAY BRACE (PAIR)



310-SB9 for shelves 9" to 15 3/4" deep 1.00 lb
310-SB18 for shelves 12" to 22" deep 1.00 lb
310-SB36 for shelves 24" to 39 3/4" deep 2.00 lb
310-SB48 for shelves 42" to 51 3/4" deep 3.20 lb

ANGLE SWAY BRACE



310-AN55 for bolt type shelving 5" x 5" 0.20 lb
310-OAS55 for offset type shelving 5" x 5" 0.20 lb

HARDWARE



310-RB63 1/4" x 5/8" rounded head bolt with square nut, box of 100 2.00 lb
310-HB63 1/4" x 5/8" rounded head bolt with hexagonal nut, box of 100 2.00 lb
310-RB100 1/4" x 1" rounded head bolt with square nut, box of 100 2.50 lb

SIDE AND BACK PANEL FOR BOLTED TYPE SHELVING



310-OS939	9" x 39"	2.50 lb
310-OS945	9" x 45"	2.90 lb
310-OS951	9" x 51"	3.30 lb
310-OS1239	12" x 39"	3.00 lb
310-OS1245	12" x 45"	4.00 lb
310-OS1251	12" x 51"	5.00 lb
310-OS1539	15" x 39"	3.50 lb
310-OS1545	15" x 45"	3.50 lb
310-OS1551	15" x 51"	5.20 lb
310-OS1839	18" x 39"	4.50 lb
310-OS1845	18" x 45"	5.00 lb
310-OS1851	18" x 51"	6.00 lb
310-OS2139	21" x 39"	5.70 lb
310-OS2145	21" x 45"	6.50 lb
310-OS2151	21" x 51"	7.40 lb
310-OB2439	24" x 39"	6.00 lb
310-OB2445	24" x 45"	7.00 lb
310-OB2451	24" x 51"	8.00 lb
310-OB3039	30" x 39"	7.50 lb
310-OB3045	30" x 45"	8.00 lb
310-OB3051	30" x 51"	9.50 lb
310-OB3639	36" x 39"	9.00 lb
310-OB3645	36" x 45"	11.00 lb
310-OB3651	36" x 51"	12.00 lb
310-OB4239	42" x 39"	10.50 lb
310-OB4245	42" x 45"	13.50 lb
310-OB4251	42" x 51"	15.50 lb
310-OB4839	48" x 39"	12.00 lb
310-OB4845	48" x 45"	15.00 lb
310-OB4851	48" x 51"	16.00 lb

PANEL CONFIGURATION ACCORDING TO HEIGHT

63"	2 panel of 39"
75"	2 panel of 39"
87"	2 panel of 45"
99"	2 panel of 51"
111"	3 panel of 39"
123"	3 panel of 45"
135"	3 panel of 51"
147"	3 panel of 51"
171"	4 panel of 45"

aisle brace for offset type shelving



310-OAB30	30"	4.60 lb
310-OAB36	36"	5.40 lb
310-OAB42	42"	6.30 lb
310-OAB48	48"	7.10 lb
310-OAB60	60"	9.00 lb

aisle brace for bolted type shelving



310-AB30	30"	4.60 lb
310-AB36	36"	5.40 lb
310-AB42	42"	6.30 lb
310-AB48	48"	7.10 lb
310-AB60	60"	9.00 lb

kickplate for 1" offset shelving



310-OBS224	2" high x 24"	0.90 lb
310-OBS230	2" high x 30"	1.20 lb
310-OBS236	2" high x 36"	1.40 lb
310-OBS242	2" high x 42"	1.60 lb
310-OBS248	2" high x 48"	1.80 lb

kickplate for offset and bolted type shelving



310-BAS212	2" high x 12" long	0.50 lb
310-BAS215	2" high x 15" long	0.50 lb
310-BAS218	2" high x 18" long	0.50 lb
310-BAS224	2" high x 24" long	0.90 lb
310-BAS230	2" high x 30" long	1.20 lb
310-BAS236	2" high x 36" long	1.40 lb
310-BAS242	2" high x 42" long	1.60 lb
310-BAS248	2" high x 48" long	1.80 lb
310-BAS412	4" high x 12" long	0.80 lb
310-BAS415	4" high x 15" long	0.80 lb
310-BAS418	4" high x 18" long	0.80 lb
310-BAS424	4" high x 24" long	1.60 lb
310-BAS430	4" high x 30" long	2.00 lb
310-BAS436	4" high x 36" long	2.50 lb
310-BAS442	4" high x 42" long	2.80 lb
310-BAS448	4" high x 48" long	3.20 lb
310-BAS612	6" high x 12" long	1.10 lb
310-BAS615	6" high x 15" long	1.10 lb
310-BAS618	6" high x 18" long	1.10 lb
310-BAS624	6" high x 24" long	2.30 lb
310-BAS630	6" high x 30" long	2.70 lb
310-BAS636	6" high x 36" long	3.20 lb
310-BAS642	6" high x 42" long	3.50 lb
310-BAS648	6" high x 48" long	4.00 lb

L-SHAPED POST 1" x 1 3/4" BOLTED TYPE



310-RFP39	39"	2.10 lb
310-RFP51	51"	3.00 lb
310-RFP63	63"	3.30 lb
310-RFP75	75"	3.60 lb
310-RFP87	87"	3.80 lb
310-RFP99	99"	6.00 lb
310-RFP111	111"	7.00 lb
310-RFP123	123"	8.00 lb
310-RFP147	147"	10.20 lb
310-RFP171	171"	12.00 lb
310-RFP195	195"	13.50 lb

L-SHAPED POST 1 1/4" x 1 1/4" BOLTED TYPE



310-GP27	27"	1.70 lb
310-GP39	39"	3.40 lb
310-GP75	75"	4.90 lb
310-GP87	87"	5.70 lb
310-GP99	99"	6.50 lb
310-GP123	123"	8.00 lb

SWAY BRACE (PAIR)



310-SB9	<i>for shelves of 9" to 15 3/4" deep</i>	1.00 lb
310-SB18	<i>for shelves of 12" to 22" deep</i>	1.00 lb
310-SB36	<i>for shelves of 24" to 39 3/4" deep</i>	2.00 lb
310-SB48	<i>for shelves of 42" to 51 3/4" deep</i>	3.20 lb

ANGLE SWAY BRACE



310-AN55	<i>for bolted type shelving, 5" x 5"</i>	0.20 lb
----------	--	---------

SPLICE



310-SP117	<i>for bolted type shelving 1" x 1" x 7" (1 1/4" x 1 1/4")</i>	0.30 lb
-----------	--	---------

20GA REGULAR SHELF



INCREASED CAPACITY WITH REINFORCEMENTS		
Sizes	With 1 reinf.	With 2 reinf.
12" x 36"	700	950
12" x 42"	550	800
12" x 48"	450	600
15" x 36"	700	950
15" x 42"	550	750
15" x 48"	450	575
18" x 36"	700	950
18" x 42"	550	750
18" x 48"	450	575
24" x 36"	700	950
24" x 42"	550	700
24" x 48"	400	500
30" x 36"	650	800
30" x 42"	500	700
30" x 48"	350	450
36" x 36"	500	575
36" x 42"	450	550
36" x 48"	325	425



310-S924	9" x 24" - 400 lb cap.	3.80 lb
310-S930	9" x 30" - 400 lb cap.	4.80 lb
310-S936	9" x 36" - 400 lb cap.	5.00 lb
310-S942	9" x 42" - 350 lb cap.	6.90 lb
310-S948	9" x 48" - 300 lb cap.	8.90 lb

310-S1224	12" x 24" - 400 lb cap.	4.90 lb
310-S1230	12" x 30" - 400 lb cap.	5.00 lb
310-S1236	12" x 36" - 400 lb cap.	6.50 lb
310-S1242	12" x 42" - 350 lb cap.	8.00 lb
310-S1248	12" x 48" - 300 lb cap.	9.00 lb

310-S1524	15" x 24" - 400 lb cap.	5.90 lb
310-S1530	15" x 30" - 400 lb cap.	6.10 lb
310-S1536	15" x 36" - 400 lb cap.	7.10 lb
310-S1542	15" x 42" - 325 lb cap.	8.20 lb
310-S1548	15" x 48" - 300 lb cap.	9.50 lb

310-S1824	18" x 24" - 400 lb cap.	6.90 lb
310-S1830	18" x 30" - 400 lb cap.	7.00 lb
310-S1836	18" x 36" - 400 lb cap.	8.20 lb
310-S1842	18" x 42" - 300 lb cap.	9.50 lb
310-S1848	18" x 48" - 275 lb cap.	10.70 lb

310-S2124	21" x 24" - 400 lb cap.	8.70 lb
310-S2130	21" x 30" - 400 lb cap.	8.90 lb
310-S2136	21" x 36" - 400 lb cap.	10.50 lb
310-S2142	21" x 42" - 300 lb cap.	12.10 lb
310-S2148	21" x 48" - 275 lb cap.	13.70 lb

310-S2424	24" x 24" - 400 lb cap.	9.00 lb
310-S2430	24" x 30" - 400 lb cap.	9.30 lb
310-S2436	24" x 36" - 400 lb cap.	11.00 lb
310-S2442	24" x 42" - 300 lb cap.	11.90 lb
310-S2448	24" x 48" - 275 lb cap.	13.90 lb

310-S3030	30" x 30" - 300 lb cap.	13.00 lb
310-S3036	30" x 36" - 300 lb cap.	13.50 lb
310-S3042	30" x 42" - 275 lb cap.	14.00 lb
310-S3048	30" x 48" - 225 lb cap.	17.50 lb

310-S3636	36" x 36" - 275 lb cap.	16.00 lb
310-S3642	36" x 42" - 275 lb cap.	18.40 lb
310-S3648	36" x 48" - 225 lb cap.	19.50 lb

OPTION

PFS Shelf perforation (front and back lengthwise)

310-COP1	Shelf clip for 1" c/c offset post	0.06 lb
----------	-----------------------------------	---------

18GA REGULAR SHELF



INCREASED CAPACITY WITH REINFORCEMENTS

Sizes	With 1 reinf.	With 2 reinf.
12" x 36"	950	1250
12" x 42"	650	1100
12" x 48"	575	700
15" x 36"	900	1150
15" x 42"	750	900
15" x 48"	575	700
18" x 36"	875	1100
18" x 42"	750	850
18" x 48"	550	700
24" x 36"	850	1050
24" x 42"	700	850
24" x 48"	475	600
30" x 36"	675	900
30" x 42"	700	850
30" x 48"	450	525
36" x 36"	550	700
36" x 42"	550	600
36" x 48"	425	500



310-S924X	9"x 24" - 775 lb cap.	5.30 lb
310-S930X	9"x 30" - 775 lb cap.	6.30 lb
310-S936X	9"x 36" - 775 lb cap.	7.30 lb
310-S942X	9"x 42" - 550 lb cap.	8.30 lb
310-S948X	9"x 48" - 450 lb cap.	9.30 lb

310-S1224X	12"x 24" - 775 lb cap.	6.40 lb
310-S1230X	12"x 30" - 775 lb cap.	6.70 lb
310-S1236X	12"x 36" - 775 lb cap.	8.00 lb
310-S1242X	12"x 42" - 550 lb cap.	10.30 lb
310-S1248X	12"x 48" - 450 lb cap.	11.60 lb

310-S1524X	15"x 24" - 750 lb cap.	7.50 lb
310-S1530X	15"x 30" - 750 lb cap.	9.00 lb
310-S1536X	15"x 36" - 750 lb cap.	10.50 lb
310-S1542X	15"x 42" - 525 lb cap.	12.00 lb
310-S1548X	15"x 48" - 450 lb cap.	13.50 lb

310-S1824X	18"x 24" - 750 lb cap.	8.70 lb
310-S1830X	18"x 30" - 750 lb cap.	10.40 lb
310-S1836X	18"x 36" - 750 lb cap.	12.10 lb
310-S1842X	18"x 42" - 500 lb cap.	13.80 lb
310-S1848X	18"x 48" - 425 lb cap.	15.50 lb

310-S2124X	21"x 24" - 700 lb cap.	10.00 lb
310-S2130X	21"x 30" - 700 lb cap.	11.30 lb
310-S2136X	21"x 36" - 700 lb cap.	14.60 lb
310-S2142X	21"x 42" - 500 lb cap.	16.90 lb
310-S2148X	21"x 48" - 375 lb cap.	19.20 lb

310-S2424X	24"x 24" - 700 lb cap.	11.00 lb
310-S2430X	24"x 30" - 700 lb cap.	13.30 lb
310-S2436X	24"x 36" - 700 lb cap.	15.60 lb
310-S2442X	24"x 42" - 500 lb cap.	17.90 lb
310-S2448X	24"x 48" - 375 lb cap.	20.20 lb

310-S3030X	30"x 30" - 550 lb cap.	16.60 lb
310-S3036X	30"x 36" - 550 lb cap.	18.80 lb
310-S3042X	30"x 42" - 450 lb cap.	21.60 lb
310-S3048X	30"x 48" - 350 lb cap.	24.40 lb

310-S3636X	36"x 36" - 450 lb cap.	22.10 lb
310-S3642X	36"x 42" - 450 lb cap.	25.40 lb
310-S3648X	36"x 48" - 350 lb cap.	28.60 lb

OPTION

PFS Shelf perforation (front and back lengthwise)

310-COP1	Shelf clip for 1" c/c offset post	0.06 lb
----------	-----------------------------------	---------

22GA MEDIUM DUTY SHELF



Welded corners
Front and back with welded reinforcements

310-BX1224L	12" x 24" - 600 lb. cap.	4.10 lb
310-BX1230L	12" x 30" - 600 lb. cap.	5.10 lb
310-BX1236L	12" x 36" - 600 lb. cap.	6.00 lb
310-BX1242L	12" x 42" - 450 lb. cap.	6.90 lb
310-BX1248L	12" x 48" - 400 lb cap.	7.80 lb
310-BX1524L	15" x 24" - 600 lb cap.	4.70 lb
310-BX1530L	15" x 30" - 600 lb cap.	5.80 lb
310-BX1536L	15" x 36" - 600 lb cap.	7.00 lb
310-BX1542L	15" x 42" - 450 lb cap.	8.00 lb
310-BX1548L	15" x 48" - 400 lb. cap	9.10 lb
310-BX1824L	18" x 24" - 600 lb cap.	5.90 lb
310-BX1830L	18" x 30" - 600 lb cap.	6.60 lb
310-BX1836L	18" x 36" - 600 lb cap.	8.00 lb
310-BX1842L	18" x 42" - 500 lb cap.	9.20 lb
310-BX1848L	18" x 48" - 400 lb cap.	10.40 lb
310-BX2124L	21" x 24" - 550 lb cap.	6.10 lb
310-BX2130L	21" x 30" - 550 lb cap.	7.40 lb
310-BX2136L	21" x 36" - 550 lb cap.	9.00 lb
310-BX2142L	21" x 42" - 450 lb cap.	10.10 lb
310-BX2148L	21" x 48" - 400 lb cap.	11.40 lb
310-BX2424L	24" x 24" - 550 lb cap.	6.70 lb
310-BX2430L	24" x 30" - 550 lb cap.	8.20 lb
310-BX2436L	24" x 36" - 550 lb cap.	10.00 lb
310-BX2442L	24" x 42" - 450 lb cap.	11.50 lb
310-BX2448L	24" x 48" - 400 lb cap.	13.00 lb
310-BX3030L	30" x 30" - 450 lb cap.	9.90 lb
310-BX3036L	30" x 36" - 450 lb cap.	12.00 lb
310-BX3042L	30" x 42" - 340 lb cap.	13.70 lb
310-BX3048L	30" x 48" - 385 lb cap.	15.60 lb
310-BX3636L	36" x 36" - 350 lb cap.	13.90 lb
310-BX3642L	36" x 42" - 300 lb cap.	16.00 lb
310-BX3648L	36" x 48" - 275 lb cap.	18.20 lb



OPTION

PFS	Shelf perforation (front and back lengthwise)	
310-COP1	Shelf clip for 1" c/c offset post	0.06 lb

20GA MEDIUM DUTY SHELF



Welded corners
Front and back with welded reinforcements

310-BX1224	12"x 24" - 850 lb. cap.	4.80 lb
310-BX1230	12"x 30" - 850 lb. cap.	5.80 lb
310-BX1236	12"x 36" - 850 lb. cap.	7.20 lb
310-BX1242	12"x 42" - 650 lb. cap.	8.40 lb
310-BX1248	12"x 48" - 550 lb. cap.	9.50 lb
310-BX1524	15"x 24" - 825 lb cap.	5.60 lb
310-BX1530	15"x 30" - 825 lb cap.	6.80 lb
310-BX1536	15"x 36" - 825 lb cap.	8.40 lb
310-BX1542	15"x 42" - 625 lb cap.	9.70 lb
310-BX1548	15"x 48" - 600 lb. cap.	11.00 lb
310-BX1824	18"x 24" - 850 lb cap.	6.30 lb
310-BX1830	18"x 30" - 850 lb cap.	7.70 lb
310-BX1836	18"x 36" - 850 lb cap.	9.60 lb
310-BX1842	18"x 42" - 650 lb cap.	11.10 lb
310-BX1848	18"x 48" - 550 lb cap.	12.60 lb
310-BX2124	21"x 24" - 850 lb cap.	7.10 lb
310-BX2130	21"x 30" - 850 lb cap.	8.70 lb
310-BX2136	21"x 36" - 850 lb cap.	10.80 lb
310-BX2142	21"x 42" - 650 lb cap.	11.80 lb
310-BX2148	21"x 48" - 550 lb cap.	13.40 lb
310-BX2424	24"x 24" - 850 lb cap.	7.90 lb
310-BX2430	24"x 30" - 850 lb cap.	9.70 lb
310-BX2436	24"x 36" - 850 lb cap.	12.00 lb
310-BX2442	24"x 42" - 650 lb cap.	13.80 lb
310-BX2448	24"x 48" - 550 lb cap.	15.70 lb
310-BX3030	30"x 30" - 650 lb cap.	11.60 lb
310-BX3036	30"x 36" - 650 lb cap.	14.40 lb
310-BX3042	30"x 42" - 625 lb cap.	16.60 lb
310-BX3048	30"x 48" - 500 lb cap.	18.80 lb
310-BX3242	32"x 42" - 525 lb cap.	18.00 lb
310-BX3636	36"x 36" - 550 lb cap.	16.80 lb
310-BX3642	36"x 42" - 525 lb cap.	19.30 lb
310-BX3648	36"x 48" - 500 lb cap.	22.00 lb



OPTION

PFS	Shelf perforation (front and back lengthwise)	
310-COP1	Shelf clip for 1" c/c offset post	0.06 lb

18GA MEDIUM DUTY SHELF



Welded corners

Front and back with welded reinforcements

310-BX1224X	12" x 24" - 1100 lb. cap.	6.30 lb
310-BX1230X	12" x 30" - 1100 lb. cap.	7.10 lb
310-BX1236X	12" x 36" - 1100 lb. cap.	9.10 lb
310-BX1242X	12" x 42" - 900 lb. cap.	10.40 lb
310-BX1248X	12" x 48" - 750 lb cap.	11.80 lb

310-BX1524X	15" x 24" - 1100 lb cap.	7.20 lb
310-BX1530X	15" x 30" - 1100 lb cap.	8.90 lb
310-BX1536X	15" x 36" - 1100 lb. cap	10.50 lb
310-BX1542X	15" x 42" - 900 lb. cap	12.20 lb
310-BX1548X	15" x 48" - 850 lb. cap	13.80 lb

310-BX1824X	18" x 24" - 1200 lb cap.	8.30 lb
310-BX1830X	18" x 30" - 1200 lb cap.	10.20 lb
310-BX1836X	18" x 36" - 1200 lb cap.	12.10 lb
310-BX1842X	18" x 42" - 950 lb cap.	13.90 lb
310-BX1848X	18" x 48" - 900 lb cap.	15.80 lb

310-BX2124X	21" x 24" - 1250 lb cap.	9.40 lb
310-BX2130X	21" x 30" - 1250 lb cap.	11.00 lb
310-BX2136X	21" x 36" - 1250 lb cap.	13.00 lb
310-BX2142X	21" x 42" - 1000 lb cap.	15.00 lb
310-BX2148X	21" x 48" - 900 lb cap.	17.00 lb

310-BX2424X	24" x 24" - 1200 lb cap.	10.00 lb
310-BX2430X	24" x 30" - 1200 lb cap.	12.00 lb
310-BX2436X	24" x 36" - 1200 lb cap.	15.10 lb
310-BX2442X	24" x 42" - 1000 lb cap.	17.40 lb
310-BX2448X	24" x 48" - 900 lb cap.	19.70 lb

310-BX3030X	30" x 30" - 1200 lb cap.	15.00 lb
310-BX3036X	30" x 36" - 1200 lb cap.	18.10 lb
310-BX3042X	30" x 42" - 900 lb cap.	20.90 lb
310-BX3048X	30" x 48" - 750 lb cap.	23.60 lb

310-BX3242X	32" x 42" - 850 lb cap.	22.60 lb
-------------	-------------------------	----------

310-BX3636X	36" x 36" - 900 lb cap.	22.10 lb
310-BX3642X	36" x 42" - 850 lb cap.	24.30 lb
310-BX3648X	36" x 48" - 750 lb cap.	27.50 lb



OPTION

PFS *Shelf perforation (front and back lengthwise)*

310-COP1	<i>Shelf clip for 1" c/c offset post</i>	0.06 lb
----------	--	---------

REGULAR SHELF REINFORCEMENT 1" x 1" - 12ga



Shelf not included

310-RB18	18"	0.70 lb
310-RB21	21"	1.00 lb
310-RB24	24"	1.40 lb
310-RB30	30"	1.70 lb
310-RB36	36"	2.00 lb
310-RB42	42"	2.40 lb
310-RB48	48"	2.70 lb

LABEL MOULDING



310-LH24	24"	0.20 lb
310-LH30	30"	0.30 lb
310-LH36	36"	0.40 lb
310-LH42	42"	0.50 lb
310-LH48	48"	0.60 lb

SHELF BOX (DRAWER)



310-SB5410	5 ½" x 4 5/8" x 10 7/8"	2.20 lb
310-SB8410	8 ¼" x 4 5/8" x 10 7/8"	2.70 lb
310-SB11410	11" x 4 5/8" x 10 7/8"	3.30 lb
310-SB5416	5 ½" x 4 5/8" x 16 7/8"	3.00 lb
310-SB8416	8 ¼" x 4 5/8" x 16 7/8"	3.80 lb
310-SB11416	11" x 4 5/8" x 16 7/8"	4.60 lb
310-SB5422	5 ½" x 4 5/8" x 22 7/8"	3.90 lb
310-SB8422	8 ¼" x 4 5/8" x 22 7/8"	4.80 lb
310-SB11422	11" x 4 5/8" x 22 7/8"	5.90 lb

SHELF BOX DIVIDER



310-SBD5	5"	0.30 lb
310-SBD8	8"	0.50 lb
310-SBD11	11"	1.00 lb

SHELF BOX GUIDE

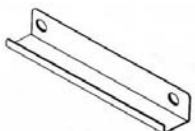

310-SBG12	12"	0.30 lb
310-SBG18	18"	0.30 lb
310-SBG24	24"	0.40 lb

BIN FRONT FOR BOLTED TYPE SHELVING



310-BF224	2"x 24"	0.90 lb
310-BF230	2"x 30"	1.20 lb
310-BF236	2"x 36"	1.40 lb
310-BF242	2"x 42"	1.60 lb
310-BF248	2"x 48"	1.80 lb
310-BF424	4"x 24"	1.60 lb
310-BF430	4"x 30"	2.00 lb
310-BF436	4"x 36"	2.50 lb
310-BF442	4"x 42"	2.80 lb
310-BF448	4"x 48"	3.20 lb
310-BF624	6"x 24"	2.30 lb
310-BF630	6"x 30"	2.80 lb
310-BF636	6"x 36"	4.00 lb
310-BF642	6"x 42"	4.40 lb
310-BF648	6"x 48"	5.10 lb

BIN FRONT FOR BOX TYPE POST



310-OBBP324	3" x 24"	0.90 lb
310-OBBP330	3" x 30"	1.20 lb
310-OBBP336	3" x 36"	1.40 lb
310-OBBP342	3" x 42"	1.60 lb
310-OBBP348	3" x 48"	1.90 lb

BIN FRONT FOR OFFSET TYPE POST



310-OBF124	1-1/2" x 24"	0.60 lb
310-OBF130	1-1/2" x 30"	0.80 lb
310-OBF136	1-1/2" x 36"	0.90 lb
310-OBF142	1-1/2" x 42"	1.10 lb
310-OBF148	1-1/2" x 48"	1.20 lb
310-OBF324	3" x 24"	0.90 lb
310-OBF330	3" x 30"	1.20 lb
310-OBF336	3" x 36"	1.40 lb
310-OBF342	3" x 42"	1.70 lb
310-OBF348	3" x 48"	1.90 lb
310-OBF624	6" x 24"	1.10 lb
310-OBF630	6" x 30"	1.40 lb
310-OBF636	6" x 36"	1.60 lb
310-OBF642	6" x 42"	1.90 lb
310-OBF648	6" x 48"	2.20 lb

DIVIDER

ADJUSTABLE



310-SD412	4" high x 12" deep	1.20 lb
310-SD415	4" high x 15" deep	1.50 lb
310-SD418	4" high x 18" deep	1.70 lb
310-SD424	4" high x 24" deep	2.20 lb
310-SD612	6" high x 12" deep	1.70 lb
310-SD615	6" high x 15" deep	1.80 lb
310-SD618	6" high x 18" deep	1.90 lb
310-SD624	6" high x 24" deep	2.50 lb
310-SD812	8" high x 12" deep	2.00 lb
310-SD815	8" high x 15" deep	2.00 lb
310-SD818	8" high x 18" deep	2.10 lb
310-SD824	8" high x 24" deep	2.80 lb

PARTIAL DIVIDER

310-PD1224	12" high x 24" deep	4.20 lb
310-PD1236	12" high x 36" deep	6.30 lb

FOR BOLTED OR OFFSET TYPE



310-BD612	6" high x 12" deep	0.80 lb
310-BD615	6" high x 15" deep	1.10 lb
310-BD618	6" high x 18" deep	1.30 lb
310-BD624	6" high x 24" deep	1.60 lb
310-BD912	9" high x 12" deep	0.90 lb
310-BD915	9" high x 15" deep	1.10 lb
310-BD918	9" high x 18" deep	1.30 lb
310-BD924	9" high x 24" deep	1.80 lb
310-BD1212	12" high x 12" deep	1.30 lb
310-BD1215	12" high x 15" deep	2.00 lb
310-BD1218	12" high x 18" deep	2.50 lb
310-BD1224	12" high x 24" deep	2.90 lb
310-BD1512	15" high x 12" deep	1.70 lb
310-BD1515	15" high x 15" deep	2.00 lb
310-BD1518	15" high x 18" deep	2.50 lb
310-BD1524	15" high x 24" deep	3.80 lb
310-BD1812	18" high x 12" deep	1.60 lb
310-BD1815	18" high x 15" deep	2.50 lb
310-BD1818	18" high x 18" deep	3.20 lb
310-BD1824	18" high x 24" deep	4.60 lb

OPTION



310-CBDIV	Divider clip (unit)	0.08 lb
310-CBDIVBX	Divider clip (box of 100 pcs)	0.50 lb

DIVIDER

FOR BOLTED TYPE SHELVING ONLY



310-BD812	8" high x 12" deep	1.00 lb
310-BD815	8" high x 15" deep	1.60 lb
310-BD818	8" high x 18" deep	1.90 lb
310-BD824	8" high x 24" deep	2.50 lb
310-BD1012	10" high x 12" deep	1.00 lb
310-BD1015	10" high x 15" deep	1.60 lb
310-BD1018	10" high x 18" deep	1.90 lb
310-BD1024	10" high x 24" deep	2.50 lb
310-BD1412	14" high x 12" deep	1.70 lb
310-BD1415	14" high x 15" deep	2.10 lb
310-BD1418	14" high x 18" deep	2.50 lb
310-BD1424	14" high x 24" deep	2.90 lb
310-BD1612	16" high x 12" deep	1.90 lb
310-BD1615	16" high x 15" deep	2.20 lb
310-BD1618	16" high x 18" deep	2.80 lb
310-BD1624	16" high x 24" deep	3.80 lb



OPTION

310-CBDIV	Divider clip (unit)	0.08 lb
310-CBDIVBX	Divider clip (box of 100 pcs)	0.50 lb

HARDWARE



310-RB63	¼" x 5/8" rounded head bolt with square nut, box of 100	2.00 lb
310-HB63	¼" x 5/8" rounded head bolt with hexagonal nut, box of 100	2.00 lb
310-RB100	¼" x 1" rounded head bolt with square nut, box of 100	2.50 lb

RIVET TYPE POST



LIGHT DUTY - 1 1/2" x 1 1/2"

310-RP36	36"	1.90 <i>lb</i>
310-RP48	48"	2.60 <i>lb</i>
310-RP60	60"	3.20 <i>lb</i>
310-RP72	72"	3.80 <i>lb</i>
310-RP84	84"	4.50 <i>lb</i>
310-RP96	96"	5.10 <i>lb</i>
310-RP108	108"	5.80 <i>lb</i>
310-RP120	120"	6.40 <i>lb</i>



MEDIUM DUTY - 1 7/8" x 1 7/8"

310-RPH72	72"	4.80 <i>lb</i>
310-RPH84	84"	5.60 <i>lb</i>
310-RPH96	96"	6.40 <i>lb</i>
310-RPH108	108"	7.20 <i>lb</i>
310-RPH120	120"	8.00 <i>lb</i>
310-RPH144	144"	9.60 <i>lb</i>
310-RPH168	168"	11.20 <i>lb</i>
310-RPH180	180"	12.00 <i>lb</i>
310-RPH192	192"	12.80 <i>lb</i>

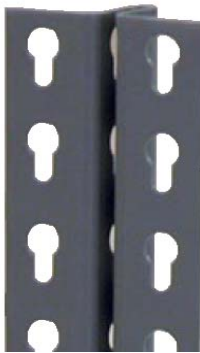

T-SHAPED POST

310-RTP60	60"	6.50 <i>lb</i>
310-RTP72	72"	8.00 <i>lb</i>
310-RTP84	84"	9.50 <i>lb</i>
310-RTP96	96"	11.00 <i>lb</i>
310-RTP108	108"	12.00 <i>lb</i>
310-RTP120	120"	12.50 <i>lb</i>
310-RTP144	144"	14.00 <i>lb</i>
310-RTP168	168"	15.50 <i>lb</i>
310-RTP180	180"	16.25 <i>lb</i>
310-RTP192	192"	17.00 <i>lb</i>

AISLE BRACE FOR RIVET TYPE SHELVING

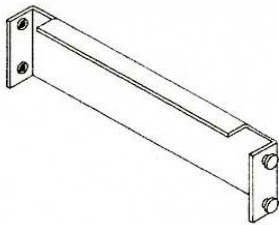

310-RRAB30	30"	4.60 <i>lb</i>
310-RRAB36	36"	5.40 <i>lb</i>
310-RRAB42	42"	6.30 <i>lb</i>
310-RRAB48	48"	7.10 <i>lb</i>
310-RRAB60	60"	9.00 <i>lb</i>

BEAM FOR RIVET TYPE SHELVING

LIGHT DUTY

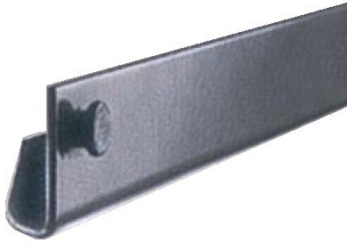

310-RBL12	12"	0.60 lb
310-RBL15	15"	0.70 lb
310-RBL16	16"	0.90 lb
310-RBL18	18"	0.90 lb
310-RBL24	24"	1.30 lb
310-RBL30	30"	1.60 lb
310-RBL32	32"	1.90 lb
310-RBL36	36"	1.90 lb
310-RBL42	42"	2.20 lb
310-RBL48	48"	2.40 lb

ANGLED



310-RBA12	12"	1.00 lb
310-RBA15	15"	1.20 lb
310-RBA16	16"	1.50 lb
310-RBA18	18"	1.50 lb
310-RBA24	24"	2.00 lb
310-RBA30	30"	2.50 lb
310-RBA32	32"	2.90 lb
310-RBA36	36"	2.90 lb
310-RBA42	42"	3.40 lb
310-RBA48	48"	3.90 lb
310-RBA54	54"	4.90 lb
310-RBA60	60"	4.90 lb
310-RBA69	69"	5.60 lb
310-RBA72	72"	5.90 lb
310-RBA84	84"	6.80 lb
310-RBA96	96"	7.80 lb

C-SHAPED



310-RBC48	48"	5.60 lb
310-RBC60	60"	7.00 lb
310-RBC69	69"	8.10 lb
310-RBC72	72"	8.40 lb
310-RBC84	84"	9.80 lb
310-RBC96	96"	11.20 lb

TIE BAR

REGULAR



310-RTB12	12"	1.40 lb
310-RTB15	15"	1.60 lb
310-RTB16	16"	1.80 lb
310-RTB18	18"	1.80 lb
310-RTB24	24"	2.30 lb
310-RTB30	30"	2.70 lb
310-RTB32	32"	3.20 lb
310-RTB36	36"	3.20 lb
310-RTB42	42"	3.60 lb
310-RTB48	48"	4.10 lb
310-RTB54	54"	5.40 lb
310-RTB60	60"	5.40 lb

FOR C-SHAPED BEAM

310-ZTB18	18"	1.50 lb
310-ZTB24	24"	1.90 lb
310-ZTB30	30"	2.30 lb
310-ZTB32	32"	2.60 lb
310-ZTB36	36"	2.90 lb
310-ZTB42	42"	3.40 lb
310-ZTB48	48"	3.90 lb

ACCESSORY FOR RIVET TYPE SHELVING



310-RTP	<i>Joiner plate (to secur to post together)</i>	0.20 lb
---------	---	---------



310-RSP	<i>1" x 1" x 5" splice (joiner)</i>	0.50 lb
---------	-------------------------------------	---------



310-FPRP	<i>Foot plate</i>	0.40 lb
----------	-------------------	---------

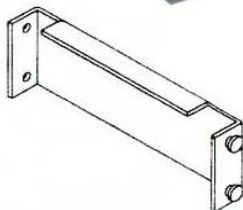

310-RRWM	<i>Wall spacer</i>	0.80 lb
----------	--------------------	---------

SLOTTED ANGLE - PAINTED FINISH

1½" x 1½" - 14ga

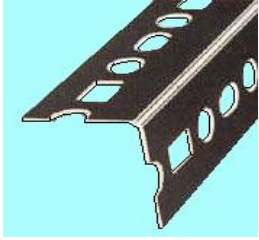

310-SA15158	1½" x 1½" x 96"	5.50 lb
310-SA15151	1½" x 1½" x 120"	6.20 lb
310-SA15151	1½" x 1½" x 144"	7.40 lb

2½" x 1½" - 14ga

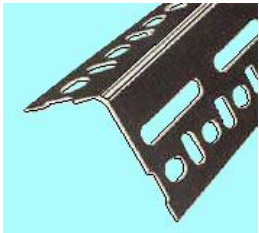

310-SA25158	1½" x 2½" x 96"	7.00 lb
310-SA25151	1½" x 2½" x 120"	8.30 lb
310-SA25151	1½" x 2½" x 144"	9.40 lb

3½" x 1½" - 14ga



310-SA30158	1½" x 3" x 96"	10.50 lb
310-SA30151	1½" x 3" x 120"	12.20 lb
310-SA30151	1½" x 3" x 144"	14.30 lb

CUTTER FOR SLOTTED ANGLE



310-SAC981		14.00 lb
------------	--	----------

CORNER REINFORCEMENT PLATE



310-SAG	<i>painting finish</i>	0.10 lb
310-SAGGAL	<i>galvanized finish</i>	0.10 lb

SERVICE CART

32" HIGH ECONOMY MODEL



22ga shelves with 3" lips, on 5" casters
(2 rigid and 2 swivel). Capacity
500 lb

310-ESC1630-2	16" x 30" with 2 shelves	30.00 lb
310-ESC1630-3	16" x 30" with 3 shelves	37.00 lb
310-ESC1630-4	16" x 30" with 4 shelves	44.00 lb
310-ESC2436-2	24" x 36" with 2 shelves	40.00 lb
310-ESC2436-3	24" x 36" with 3 shelves	51.00 lb
310-ESC2436-4	24" x 36" with 4 shelves	62.00 lb

32" HIGH ECONOMY MODEL WITH DRAWER



22ga shelves with 3" lips, on 5" casters
(2 rigid and 2 swivel), also includes
1 or 2 utility drawers. Capacity
500 lb

310-ESC1630D	16" x 30" with 1 utility drawer	30.00 lb
310-ESC2436D	24" x 36" with 1 utility drawer	37.00 lb
310-ESC2436DD	24" x 36" with 2 utility drawers	44.00 lb

35" HIGH HEAVY DUTY MODEL



18ga shelves with 2 1/4" lips, on 5" casters
(2 rigid and 2 swivel). Capacity
1000 lb

310-SC1630-2	16" x 30" with 2 shelves	36.00 lb
310-SC1630-3	16" x 30" with 3 shelves	45.00 lb
310-SC1630-4	16" x 30" with 4 shelves	54.00 lb
310-SC1836-2	18" x 36" with 2 shelves	40.00 lb
310-SC1836-3	18" x 36" with 3 shelves	50.00 lb
310-SC1836-4	18" x 36" with 4 shelves	60.00 lb
310-SC2436-2	24" x 36" with 2 shelves	50.00 lb
310-SC2436-3	24" x 36" with 3 shelves	67.00 lb
310-SC2436-4	24" x 36" with 4 shelves	84.00 lb
310-SC2448-2	24" x 48" with 2 shelves	56.00 lb
310-SC2448-3	24" x 48" with 3 shelves	76.00 lb
310-SC2448-4	24" x 48" with 4 shelves	96.00 lb



MOBILE SHELF TRUCK

57" HIGH OPEN MODEL



With 4 - 20ga shelves, 18ga base shelf, on casters (2 rigid and 2 swivel). Capacity 1000 lb

310-MST1836	18" x 36"	68.00 lb
310-MST1842	18" x 42"	82.00 lb
310-MST1848	18" x 48"	84.00 lb
310-MST2436	24" x 36"	82.00 lb
310-MST2442	24" x 42"	91.00 lb
310-MST2448	24" x 48"	100.00 lb

57" HIGH CLOSED ON 2 SIDES MODEL



With 4 - 20ga shelves, 18ga base shelf, on casters (2 rigid and 2 swivel), 2 closed sides. Capacity 1000 lb

310-MST1836CS	18" x 36"	83.00 lb
310-MST1842CS	18" x 42"	97.00 lb
310-MST1848CS	18" x 48"	99.00 lb
310-MST2436CS	24" x 36"	101.00 lb
310-MST2442CS	24" x 42"	110.00 lb
310-MST2448CS	24" x 48"	119.00 lb

57" HIGH CLOSED ON 3 SIDES MODEL



With 4 - 20ga shelves, 18ga base shelf, on casters (2 rigid and 2 swivel), 3 closed sides. Capacity 1000 lb

310-MST1836CSB	18" x 36"	98.00 lb
310-MST1842CSB	18" x 42"	114.00 lb
310-MST1848CSB	18" x 48"	118.00 lb
310-MST2436CSB	24" x 36"	116.00 lb
310-MST2442CSB	24" x 42"	127.00 lb
310-MST2448CSB	24" x 48"	138.00 lb